

# Defensas, protecciones y perfiles

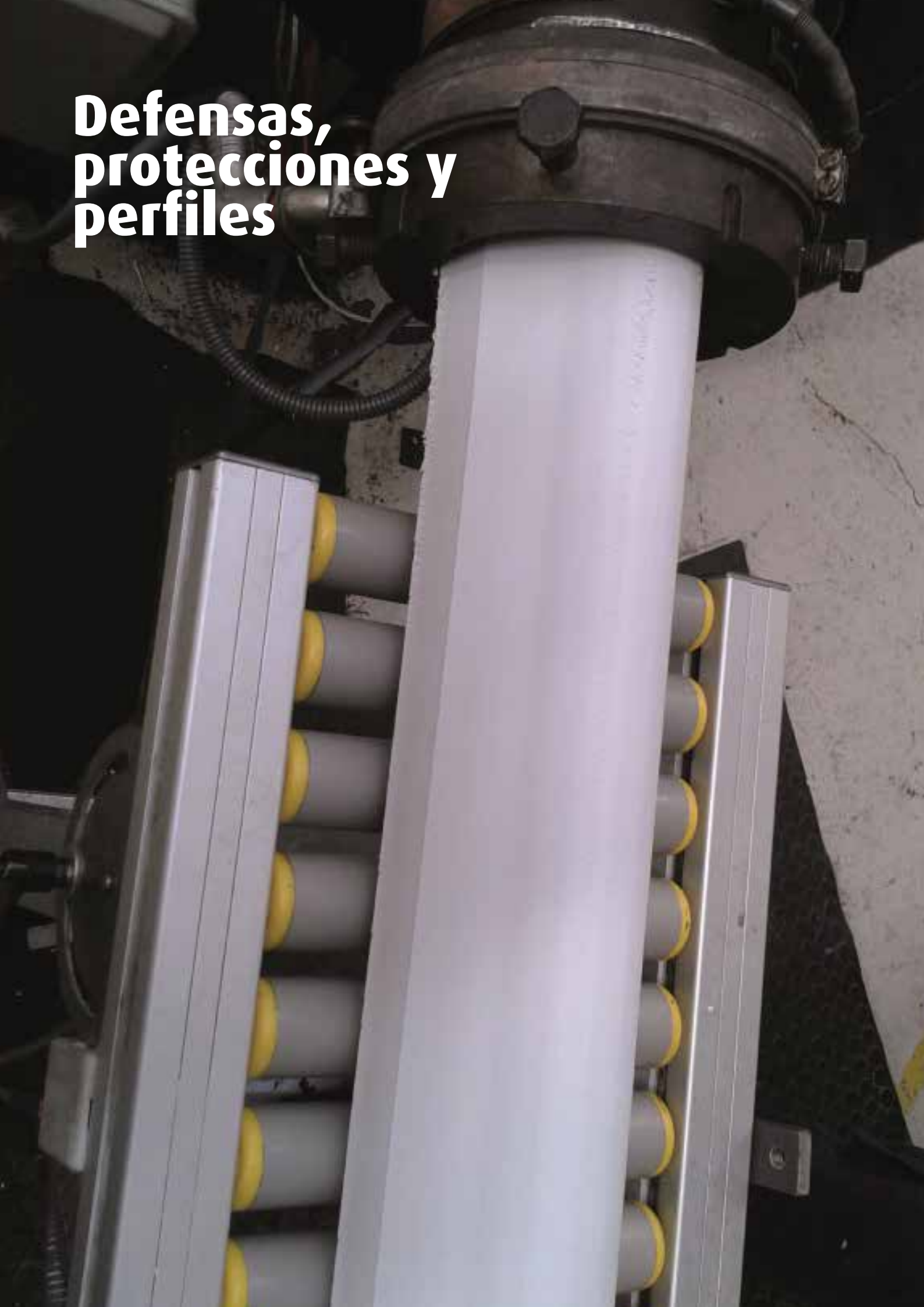

# DEFENSA FORMA D

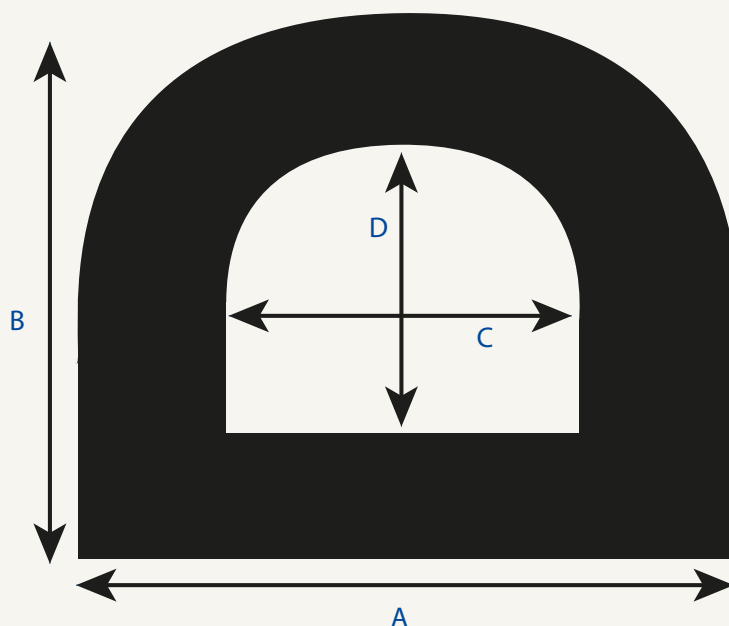

REFERENCE	A	B	C	D	LENGTH	COLOUR	KG.	STOCK
DNND50601000	50	60	20	30	1000*	BLACK	2,8	○
DNND80701000	80	70	44	34	1000*	BLACK	4,7	○
DNND100901000	100	90	60	50	1000*	BLACK	6,7	○
DNND1501501000	150	150	90	90	1000*	BLACK	16,6	□
DNND2002001000	195	195	195	195	1000**	BLACK	28,6	△
DNBD50601000	50	60	20	30	1000*	WHITE	2,7	○
DNBD80701000	80	70	44	34	1000*	WHITE	4,5	○
DNBD100901000	100	90	60	50	1000*	WHITE	6,2	○
DNBD1501501000	150	150	90	90	1000*	WHITE	16,1	□
DNBD2002001000	195	195	195	195	1000**	WHITE	27,6	△

\* Maximum length of piece: 3.000 mm

\*\* Maximum length of piece: 1.500 mm

Unit of measure: millimeters (mm)

The weight of these references is based on **EPDM 70Sh** manufactured.

Manufacturing available in **EPDM, NBR and Viton/FKM**. White and Black colors.

# DEFENSA FORMA D + ANCLAJES

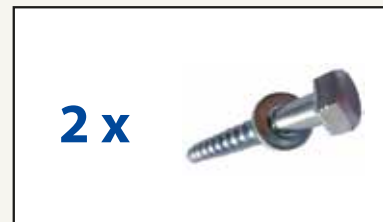
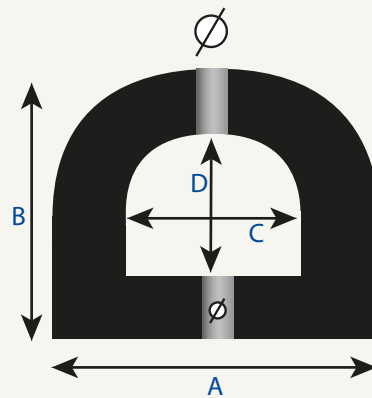
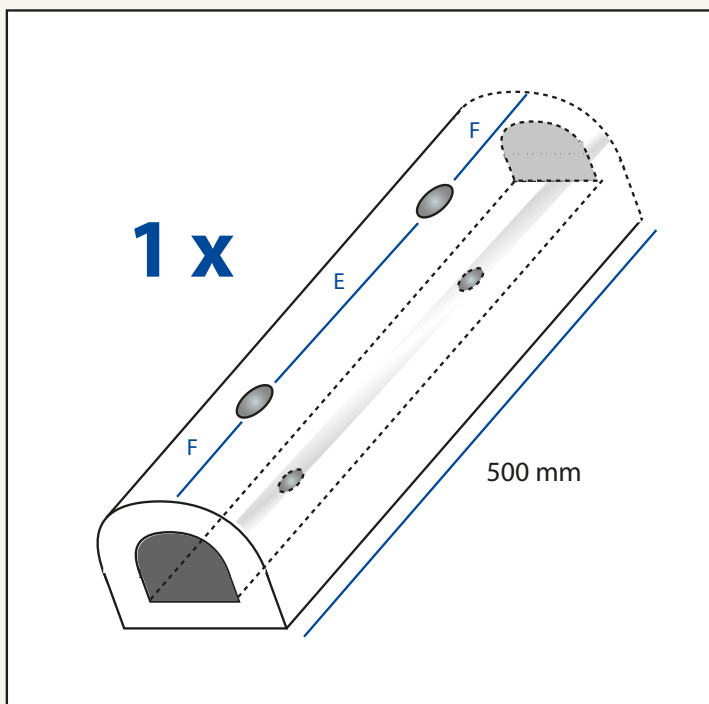

REFERENCE	A	B	C	D	E	F	KG.
DNBD10090500F	100	90	60	50	300	100	3,35
Kit con 1 defensa + 2 anclajes a medida.				Ø	Ø	LENGTH	COLOUR
				25	14	500	WHITE

# DEFENSA FORMA TRIANGULAR

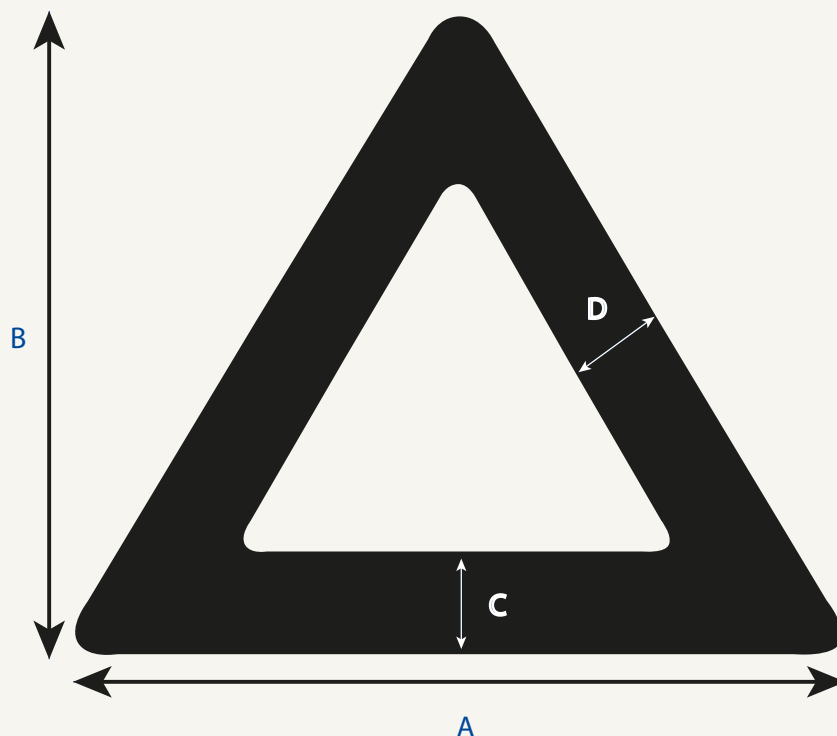

REFERENCE	A	B	C	D	LENGTH	COLOUR	KG.	STOCK
DNNT60501000	60	50	6	8	1000*	BLACK	1,4	□
DNNT80701000	80	70	7,6	10,6	1000*	BLACK	2,5	○
DNNT110951000	110	95	10,5	14	1000*	BLACK	4,7	□
DNNT1501501000	150	150	14,2	21	1000*	BLACK	10,0	○
DNNT2002001000	200	200	19	28	1000**	BLACK	17,9	△
DNBT60501000	60	50	6	8	1000*	WHITE	1,1	△
DNBT80701000	80	70	7,6	10,6	1000*	WHITE	1,9	△
DNBT110951000	110	95	10,5	14	1000*	WHITE	4,5	△
DNBT1501501000	150	150	14,2	21	1000*	WHITE	9,7	△
DNBT2002001000	200	200	19	28	1000**	WHITE	17,3	△

\* Maximum length of piece: 3.000 mm

\*\* Maximum length of piece: 2.000 mm

# DEFENSA ESPECIAL

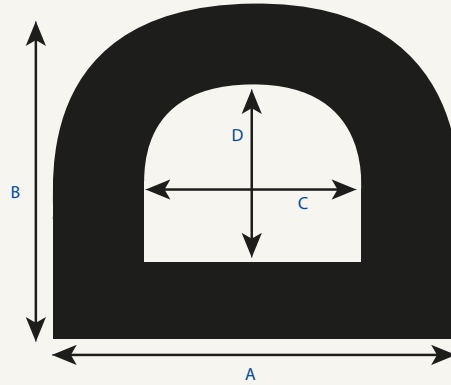

REFERENCE	A	B	C	D	LENGTH	COLOUR	KG.
DNND25151000	25	15	15	5,8	1000*	BLACK	0,31
DNND60501000	60	50	30	20	1000*	BLACK	2,7
DNND90601000	90	60	60	30	1000*	BLACK	4,0
DNND90801000	90	80	60	50	1000*	BLACK	6,8
DNND1101051000	110	105	50	50	1000*	BLACK	10,3
DNND1201201000	120	120	72	72	1000*	BLACK	10,6

\* Maximum length of piece: 3.000 mm

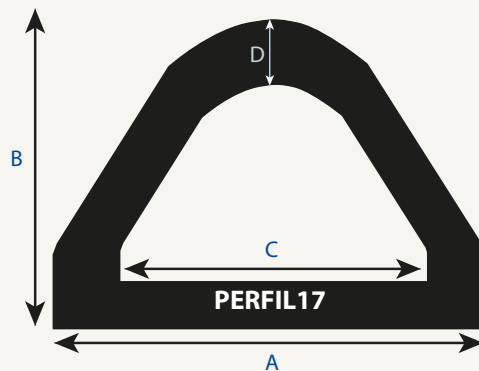

REFERENCE	A	B	C	D	LENGTH	COLOUR	KG.
PERFIL17	130,5	100	10	20	1000*	BLACK	5,96

\* Maximum length of piece: 3.000 mm

Unit of measure: millimeters (mm)

The weight of these references is based on **EPDM 70Sh** manufactured. Manufacturing available in **EPDM, NBR and Viton/FKM**. White and Black colors.

# DEFENSA ESPECIAL

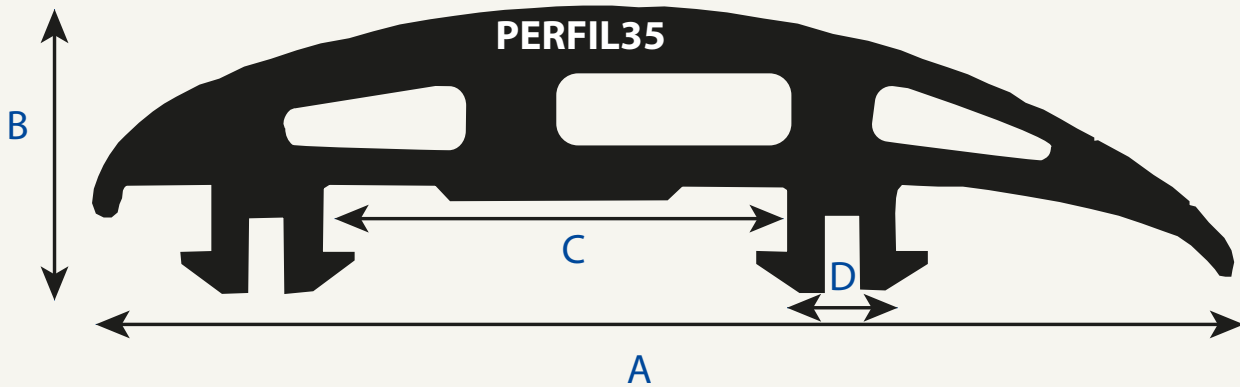

REFERENCE	A	B	C	D	LENGTH	COLOUR	KG.
<b>PERFIL35</b>	<b>148,5</b>	<b>37,1</b>	<b>61</b>	<b>14</b>	<b>1000*</b>	<b>BLACK</b>	<b>2,86</b>
* Maximum length of piece: 3.000 mm							

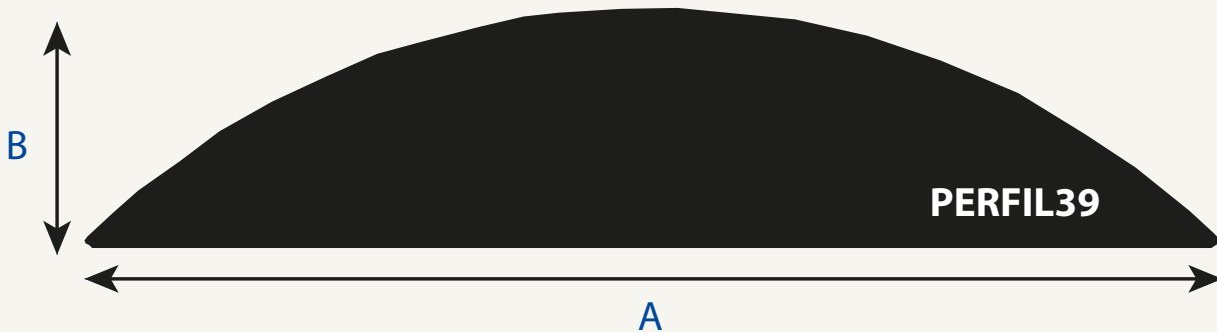

REFERENCE	A	B	C	D	LENGTH	COLOUR	KG.
<b>PERFIL39</b>	<b>190</b>	<b>40</b>	<b>-</b>	<b>-</b>	<b>1000*</b>	<b>BLACK</b>	<b>6,83</b>
* Maximum length of piece: 3.000 mm							



# DEFENSA ESPECIAL

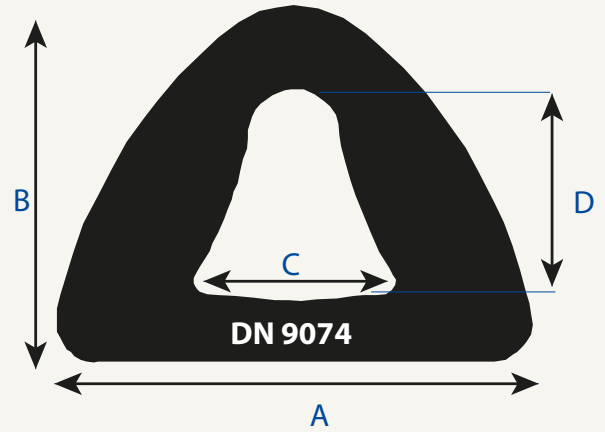
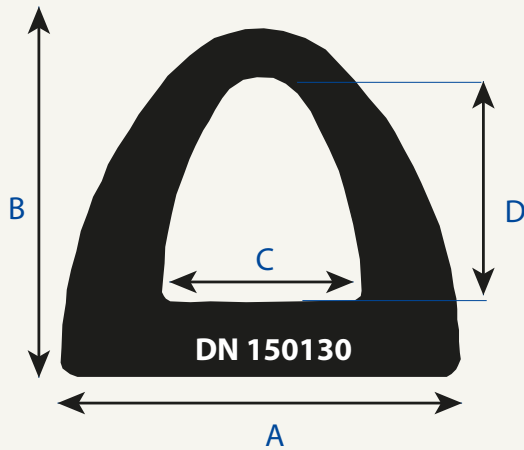

REFERENCE	A	B	C	D	LENGTH	COLOUR	KG.
DN 150130	150	130	75	84	1000*	BLACK	12,97
DN 9074	94	70	40	42	1000*	BLACK	4,82

\* Maximum length of piece: 2.500 mm

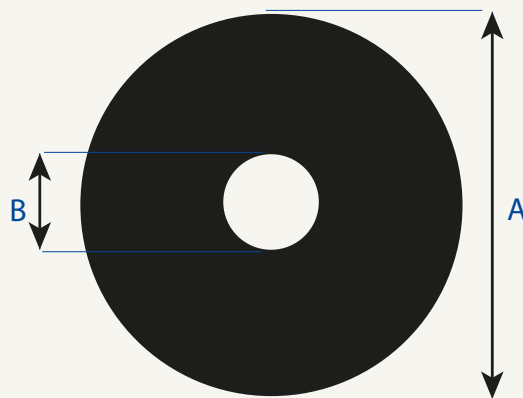

REFERENCE	A	B	C	D	LENGTH	COLOUR	KG.
PERFILCIR	100	20	-	-	1000*	BLACK	19,0
DNC160130	160	130	-	-	1000*	BLACK	8,81

\* Maximum length of piece: 3.000 mm

Unit of measure: millimeters (mm)

The weight of these references is based on **EPDM 70Sh** manufactured.  
Manufacturing available in **EPDM, NBR and Viton/FKM**. White and Black colors.

# DEFENSA ESPECIAL

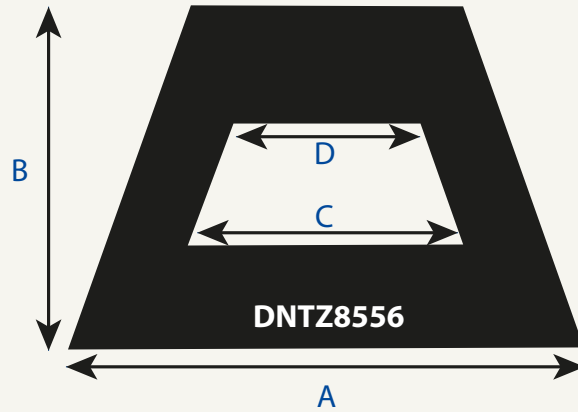

REFERENCE	A	B	C	D	LENGTH	COLOUR	KG.
<b>DNTZ8556</b>	<b>150</b>	<b>130</b>	<b>75</b>	<b>84</b>	<b>1000*</b>	<b>BLACK</b>	<b>12,97</b>
* Maximum length of piece: 2.500 mm							
** Maximum length of piece: 3.000 mm							

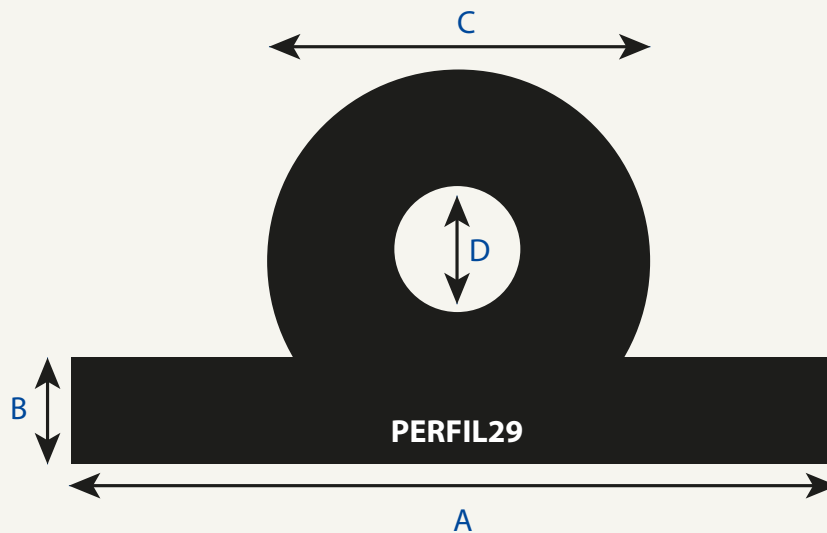

REFERENCE	A	B	C	D	LENGTH	COLOUR	KG.
<b>PERFIL29</b>	<b>152</b>	<b>19</b>	<b>76</b>	<b>25</b>	<b>1000*</b>	<b>BLACK</b>	<b>7,81</b>
* Maximum length of piece: 3.000 mm							

Unit of measure: millimeters (mm)

The weight of these references is based on **EPDM 70Sh** manufactured.  
Manufacturing available in **EPDM, NBR and Viton/FKM**. White and Black colors.



# PERFIL BOCA DE HOMBRE

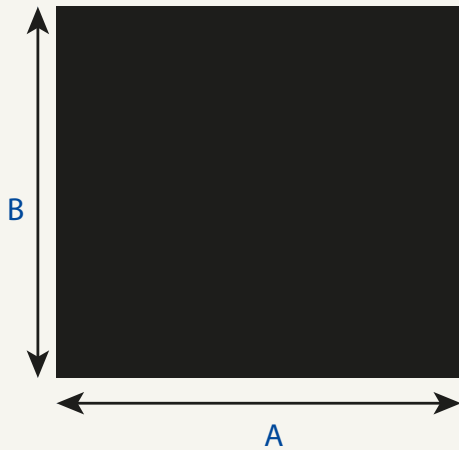

Perfil cuadrado Boca de Hombre fabricado en FKM, EPDM y NBR utilizado en los camiones cisterna.  
Square profile Manhole made of FKM, EPDM and NBR used in tank trucks.

REFERENCE	A	B	C	D	RUBBER	COLOUR	KG/MT
PERFIL 41	15	15	-	-	FKM	BLACK	0,29
PERFIL 32	20	20	-	-	FKM	BLACK	0,52
PERFIL 42	25	25	-	-	FKM	BLACK	0,80

# PERFILES



REFERENCE	A	B	C	D	E	COLOUR	KG/MT
<b>PERFIL13</b>	<b>50</b>	<b>15</b>	<b>6</b>	<b>10</b>	<b>-</b>	<b>BLACK</b>	<b>1,00</b>

REFERENCE	A	B	C	D	E	COLOUR	KG/MT
<b>PERFIL11</b>	<b>12,2</b>	<b>7</b>	<b>2</b>	<b>5</b>	<b>5</b>	<b>BLACK</b>	<b>0,08</b>

REFERENCE	A	B	C	D	E	COLOUR	KG/MT
<b>PERFIL16</b>	<b>33</b>	<b>33</b>	<b>-</b>	<b>-</b>	<b>-</b>	<b>BLACK</b>	<b>1,40</b>
<b>PERFIL30</b>	<b>35</b>	<b>35</b>	<b>-</b>	<b>-</b>	<b>-</b>	<b>BLACK</b>	<b>1,58</b>
<b>PERFIL32</b>	<b>20</b>	<b>20</b>	<b>-</b>	<b>-</b>	<b>-</b>	<b>BLACK</b>	<b>0,52</b>
<b>PERFIL40</b>	<b>60</b>	<b>60</b>	<b>-</b>	<b>-</b>	<b>-</b>	<b>BLACK</b>	<b>4,64</b>
<b>PERFIL41</b>	<b>15</b>	<b>15</b>	<b>-</b>	<b>-</b>	<b>-</b>	<b>BLACK</b>	<b>0,29</b>
<b>PERFIL42</b>	<b>25</b>	<b>25</b>	<b>-</b>	<b>-</b>	<b>-</b>	<b>BLACK</b>	<b>0,80</b>
<b>PERFIL51</b>	<b>13</b>	<b>13</b>	<b>-</b>	<b>-</b>	<b>-</b>	<b>BLACK</b>	<b>0,22</b>
<b>PERFIL53</b>	<b>16</b>	<b>16</b>	<b>-</b>	<b>-</b>	<b>-</b>	<b>BLACK</b>	<b>0,33</b>

REFERENCE	A	B	C	D	E	COLOUR	KG/MT
<b>PERFIL18</b>	<b>25</b>	<b>15</b>	<b>-</b>	<b>-</b>	<b>-</b>	<b>BLACK</b>	<b>0,48</b>
<b>PERFIL49</b>	<b>20</b>	<b>6</b>	<b>-</b>	<b>-</b>	<b>-</b>	<b>BLACK</b>	<b>0,15</b>

REFERENCE	A	B	C	D	E	COLOUR	KG/MT
<b>PERFIL27</b>	<b>12</b>	<b>13</b>	<b>6,5</b>	<b>-</b>	<b>-</b>	<b>BLACK</b>	<b>1,42</b>

REFERENCE	A	B	C	D	E	COLOUR	KG/MT
<b>PERFIL16</b>	<b>14</b>	<b>10</b>	<b>8</b>	<b>-</b>	<b>-</b>	<b>BLACK</b>	<b>0,33</b>

REFERENCE	A	B	C	D	E	COLOUR	KG/MT
<b>PERFIL31</b>	<b>15</b>	<b>15</b>	<b>10</b>	<b>5</b>	<b>-</b>	<b>BLACK</b>	<b>0,61</b>

# PERFILES



REFERENCE	A	B	C	D	E	COLOUR	KG/MT
<b>PERFIL33</b>	<b>34</b>	<b>35</b>	<b>8</b>	-	-	<b>BLACK</b>	<b>1,46</b>

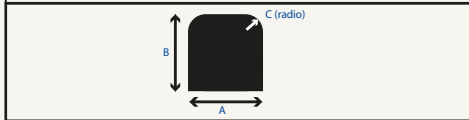

REFERENCE	A	B	C	D	E	COLOUR	KG/MT
<b>PERFIL34</b>	<b>19</b>	<b>17</b>	<b>12</b>	<b>6</b>	<b>7</b>	<b>BLACK</b>	<b>0,35</b>

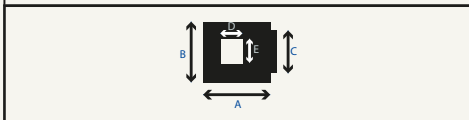

REFERENCE	A	B	C	D	E	COLOUR	KG/MT
<b>PERFIL38</b>	<b>26</b>	<b>25</b>	<b>12</b>	<b>16</b>	-	<b>BLACK</b>	<b>0,42</b>

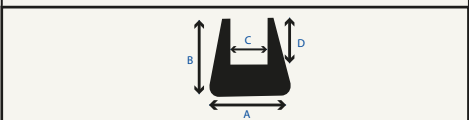

REFERENCE	A	B	C	D	E	COLOUR	KG/MT
<b>PERFIL43</b>	<b>17,23</b>	<b>14</b>	<b>22</b>	<b>3,43</b>	-	<b>BLACK</b>	<b>0,35</b>

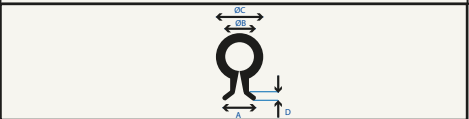

REFERENCE	A	B	C	D	E	COLOUR	KG/MT
<b>PERFIL44</b>	<b>30</b>	<b>20</b>	<b>10</b>	-	-	<b>BLACK</b>	<b>0,65</b>

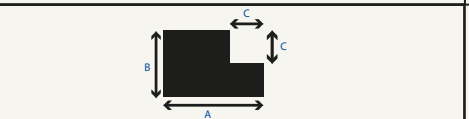

REFERENCE	A	B	C	D	E	COLOUR	KG/MT
<b>PERFIL47</b>	<b>25</b>	<b>13</b>	-	-	-	<b>BLACK</b>	<b>0,19</b>

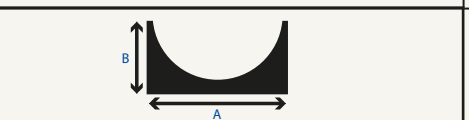

REFERENCE	A	B	C	D	E	COLOUR	KG/MT
<b>PERFIL48</b>	<b>11</b>	<b>17,9</b>	<b>27</b>	<b>13</b>	<b>9</b>	<b>BLACK</b>	<b>0,41</b>

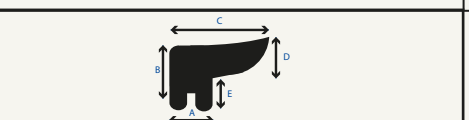

Unit of measure: millimeters (mm)

The weight of these references is based on **EPDM 70Sh** manufactured.